

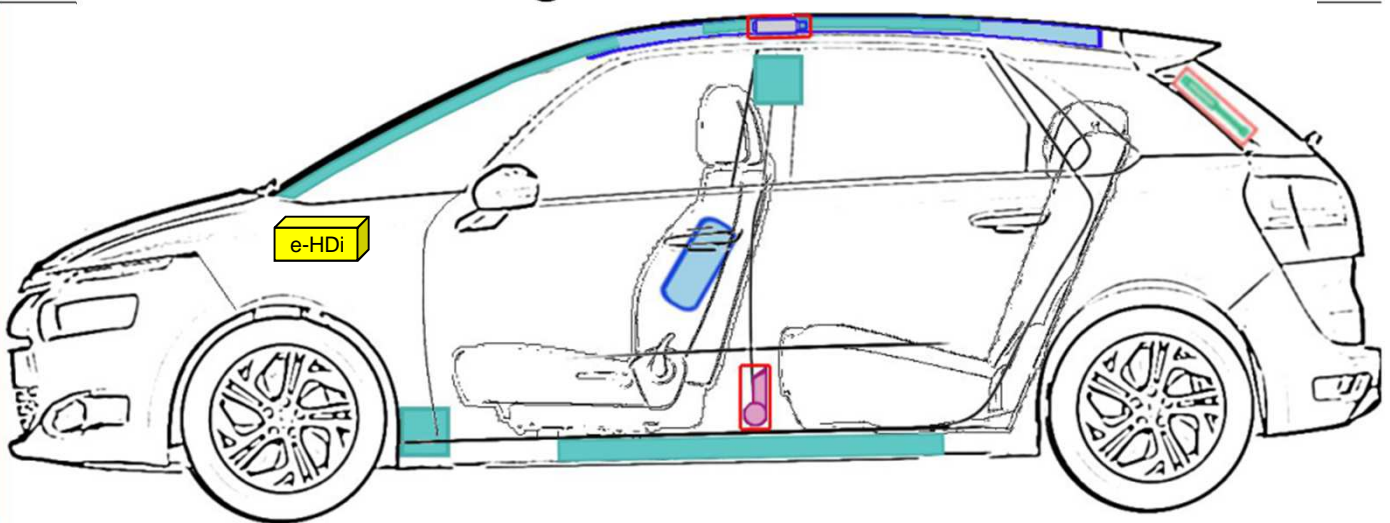

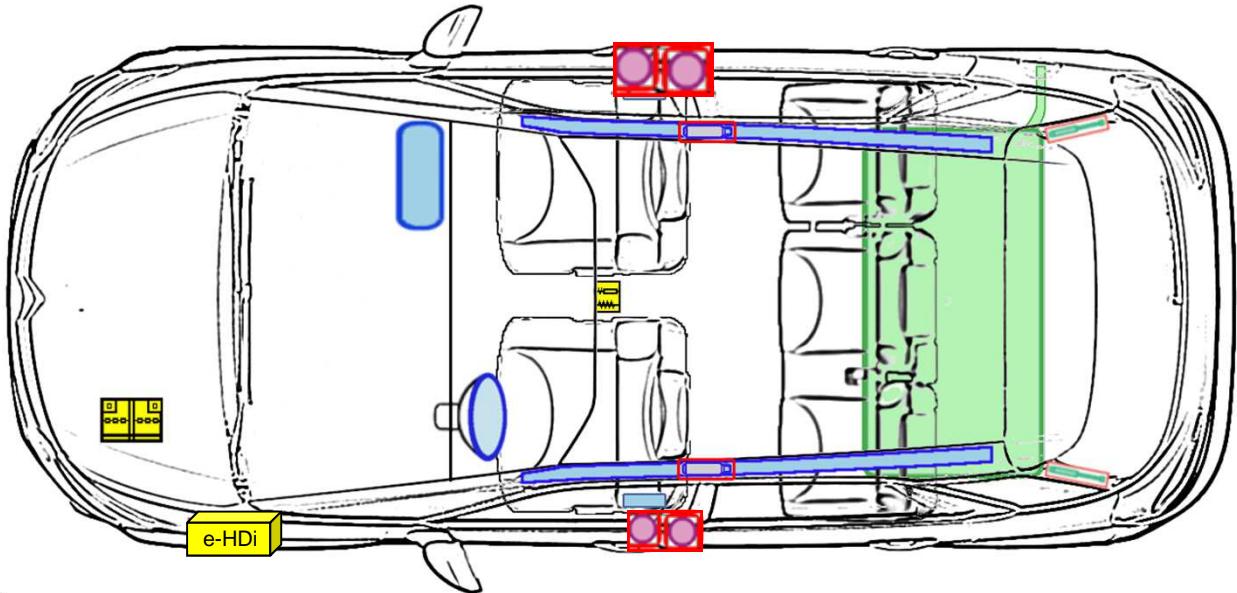















Citroën C4 Picasso (ab 2013)



Legende

	Airbag		Karosserie- verstärkung		Batterie		Steuergerät
	Gas- generator		Gurtstraffer		Überroll- schutz		Gasdruck- dämpfer
	Gastank		Sicherheits- ventil		Kraftstoff- tank		e-Booster
	Sicherungs- kasten		Hochvolt- leitung/ -komponenten		Hochvolt- -batterie		Hochvolt- trennstelle



Citroën Grand C4 Picasso (ab 2013)

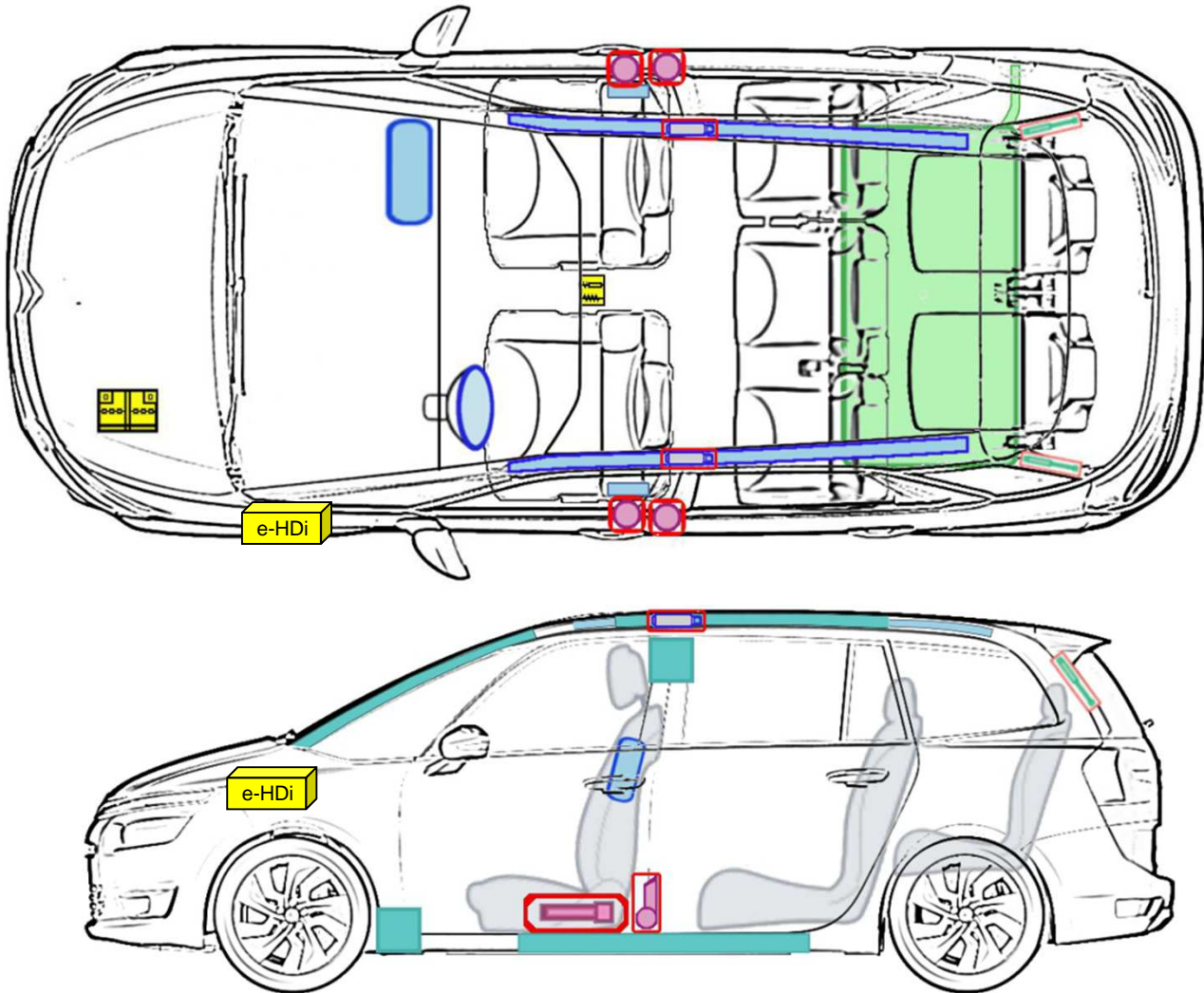

Legende

	Airbag		Karosserie- verstärkung		Batterie		Steuergerät
	Gas- generator		Gurtstraffer		Überroll- schutz		Gasdruck- dämpfer
	Gastank		Sicherheits- ventil		Kraftstoff- tank		e-Booster
	Sicherungs- kasten		Hochvolt- leitung/ -komponenten		Hochvolt- -batterie		Hochvolt- trennstelle